

WELCOME TO

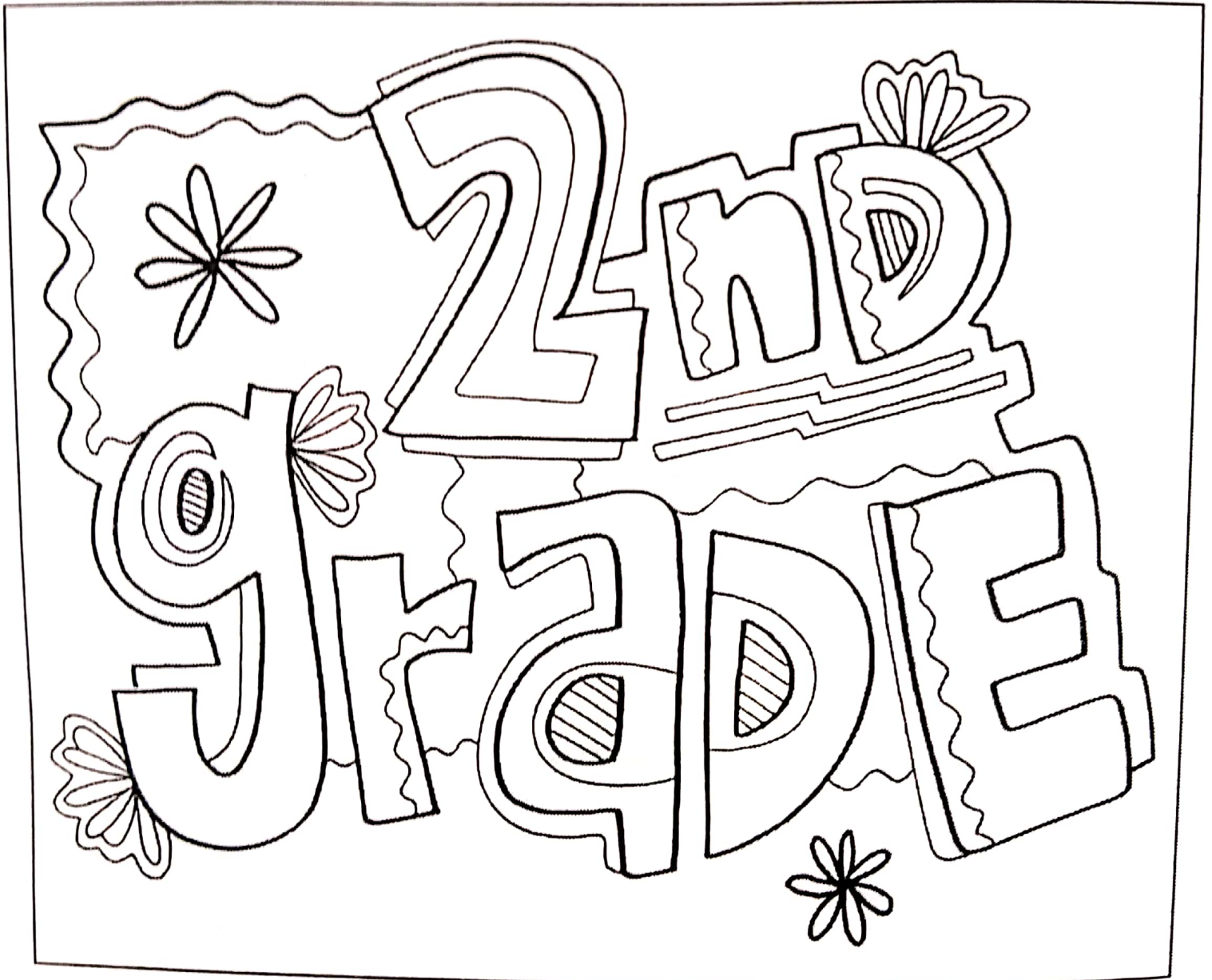

MISS LAU

1 Read and write.

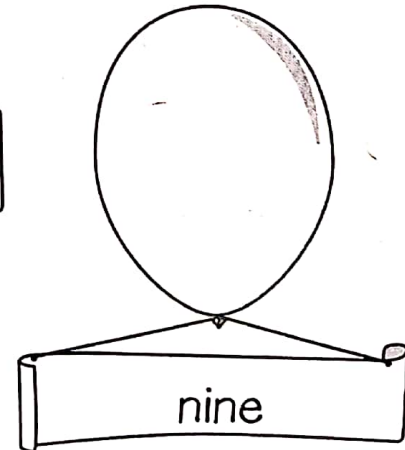
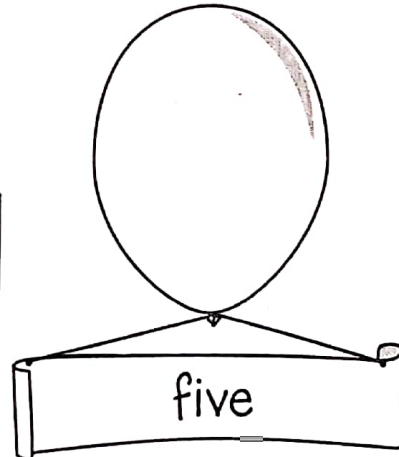
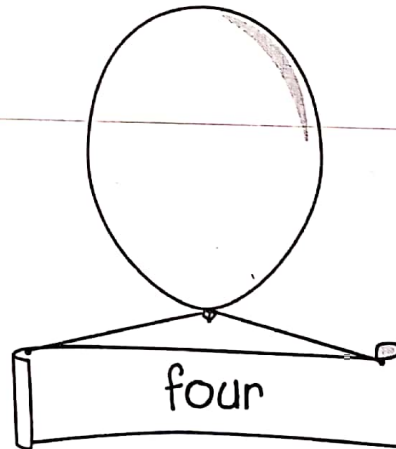
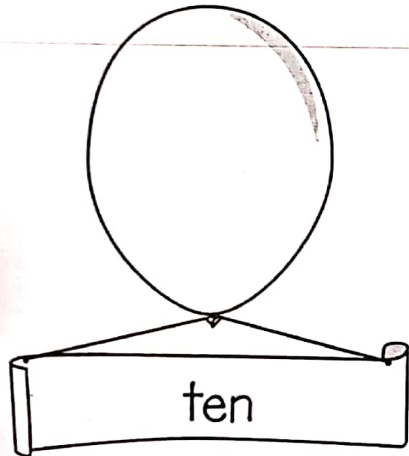
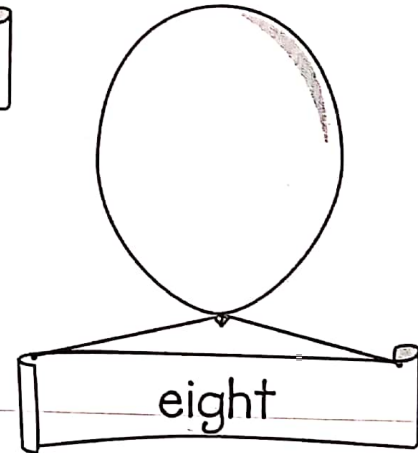
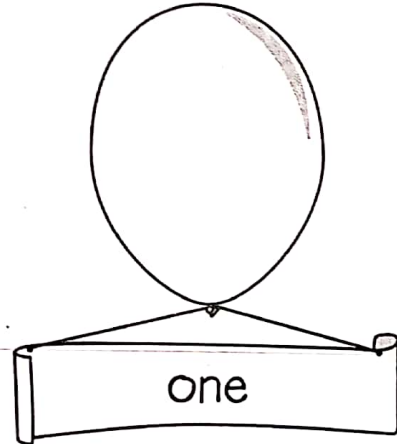
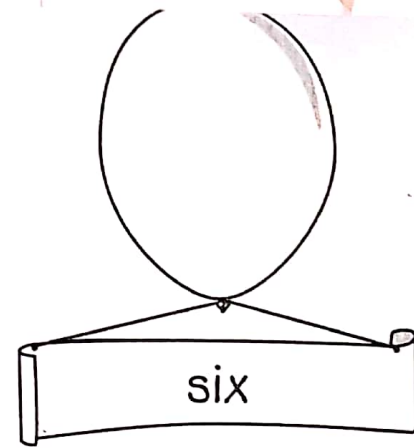
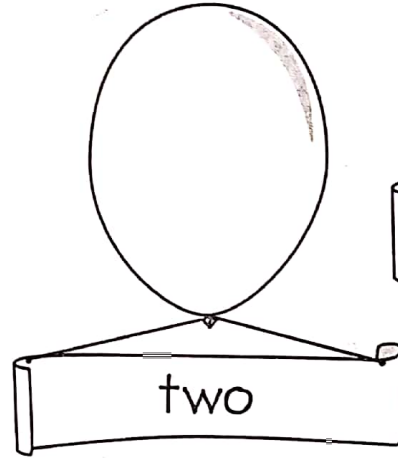
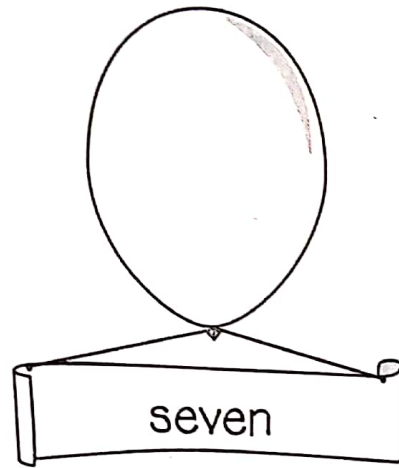
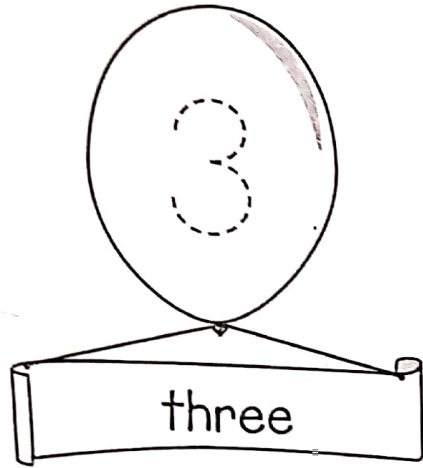

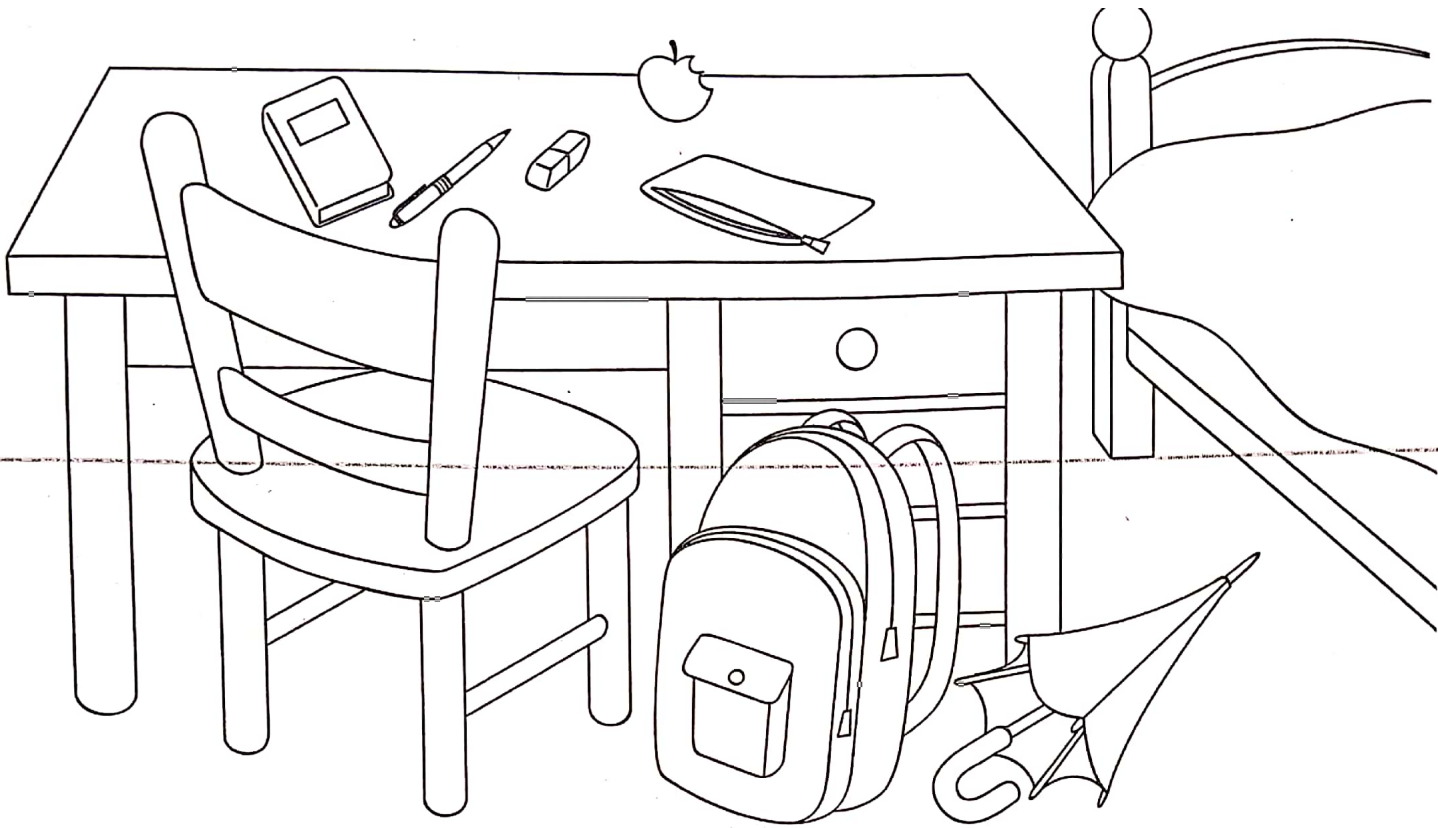

5 Read and circle. Then colour.

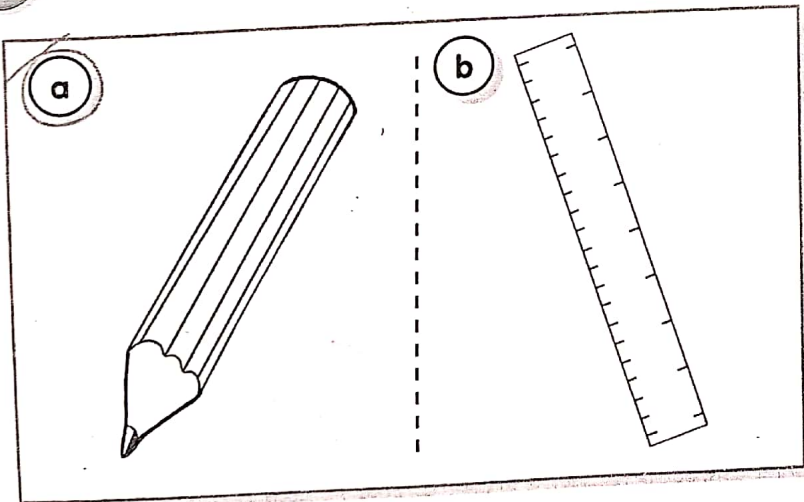

1 What's this?  
 It's a pencil.  
 What colour is it?  
 It's pink and grey.

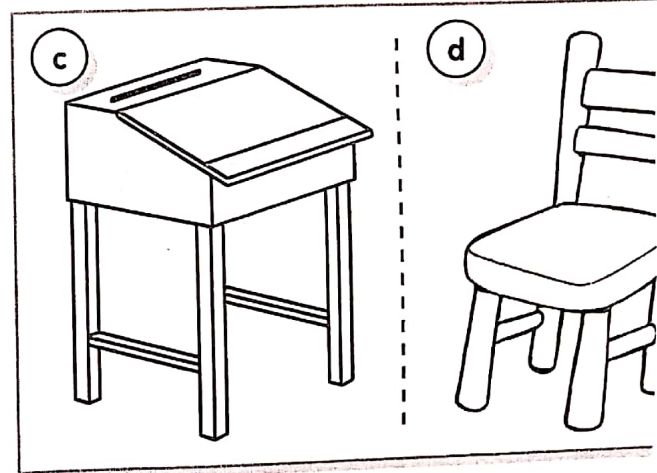

2 What's this?  
 It's a chair.  
 What colour is it?  
 It's brown and greer

Listen and colour. ☺)

3. —

1 6 9 3 8 10  
2 11 5 7 4

Look at 1. Colour by number.

